

Residential Combustion Analyzer

INSTRUCTION MANUAL

ENGLISH

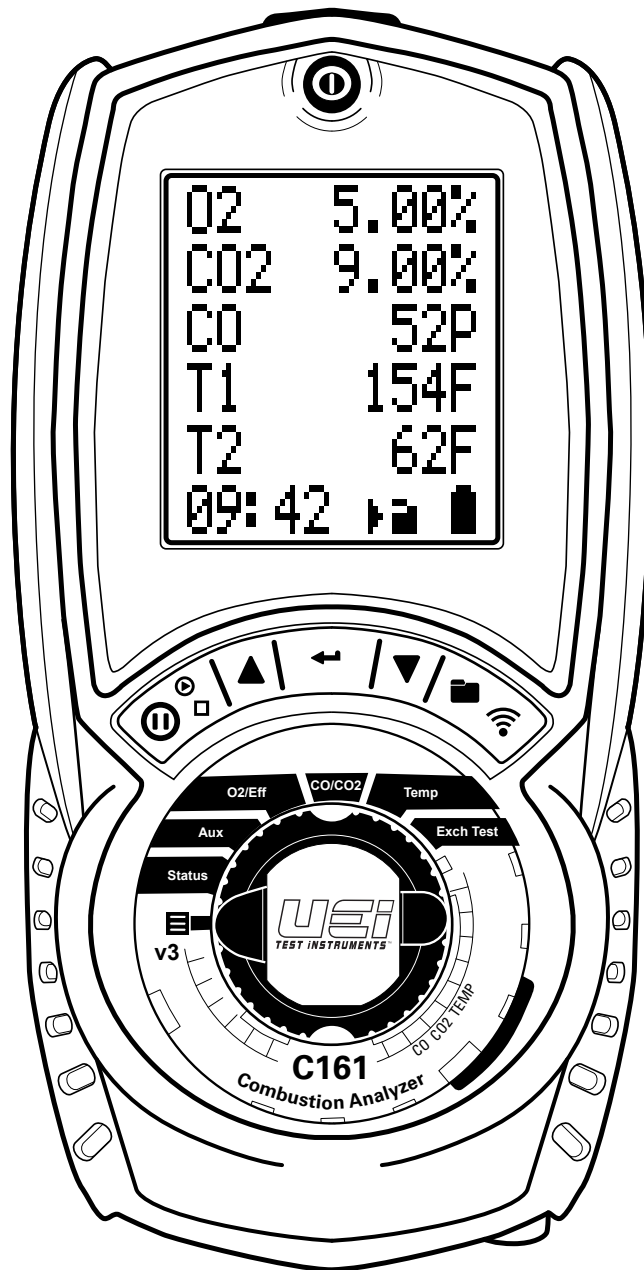

BACKED BY

UEI

SERVICE+

10

YEAR
WARRANTY



RoHS
Compliant

REACH
Compliant

TABLE OF CONTENTS

<p>Functions 2</p> <p>Features 2</p> <p>General Specifications 3</p> <p>Important Safety Warnings 3</p> <p>Symbols 3</p> <p>Analyzer Overview 4-5</p> <p>Overview 6</p> <p>Pre Test Checklist 6</p> <p>Setting Inlet Temperature 6</p> <p>Analyzer Connections 6</p> <p>Emptying & Cleaning the In-Line Water Trap 7</p> <p>Changing The Particle Filter 7</p> <p>Quick Start 7</p> <p>Fresh Air Purge 7</p> <p>Measuring Flue Gases 7</p> <p>Display Parameters 8-9</p> <p>Status Screen 9</p> <p>Status Bar 10</p> <p style="padding-left: 20px;">Status Bar Icons 10</p> <p style="padding-left: 20px;">Status Bar Icon Layout 10</p> <p style="padding-left: 20px;">Status Bar Menu Options 10</p> <p style="padding-left: 20px;">Status Bar Options Table 10</p> <p>Menu 11</p> <p style="padding-left: 20px;">Using the Menu 11</p> <p>Stored Logs Memory 12</p> <p style="padding-left: 20px;">Menu Options 12</p> <p style="padding-left: 20px;">Viewing Stored Logs 13</p> <p style="padding-left: 20px;">Log View Menu Options 13</p> <p style="padding-left: 20px;">Navigating Stored Logs 13</p> <p style="padding-left: 20px;">Log Navigation Menu Options 14</p>	<p>Temperature Testing 14</p> <p style="padding-left: 20px;">Temperature Display 14</p> <p style="padding-left: 20px;">Viewing/Printing 14</p> <p>Heat exchanger test 15</p> <p>Printouts 16</p> <p>Specifications 17</p> <p>Certification 17</p> <p>Where to Test 18-19</p> <p>What Results are Generally Acceptable 19</p> <p style="padding-left: 20px;">What Results Are Generally Acceptable 19</p> <p style="padding-left: 20px;">Typical Excess Air Level 19</p> <p>Powering Off 20</p> <p>Post Test 20</p> <p>General Maintenance 20</p> <p>Cold Weather Precautions 20</p> <p>Replacing the Batteries 21</p> <p>Canadian Annual Recertification Services 21</p> <p>Usa Annual Recertification Services 22</p> <p>Product Registration 22</p> <p>Other Important Factors Relating to Combustion 23</p> <p>Combustion Measurement Terms 23</p> <p style="padding-left: 20px;">Nett Temperature 23</p> <p style="padding-left: 20px;">Draft 23</p> <p style="padding-left: 20px;">Efficiency 23</p> <p style="padding-left: 20px;">Combustion Efficiency Calculations 23</p> <p style="padding-left: 20px;">CO Air Free 23</p> <p>Disposal 24</p> <p>Cleaning 24</p> <p>Storage 24</p> <p>Warranty 24</p>
--	--

FUNCTIONS

- **Measures:** Flue temperature, Inlet temperature (Internal & External Sensor), CO, CO₂
- **Calculates:** CO/CO₂ Ratio, Efficiency (Nett or Gross), Efficiency (High Condensing), Excess Air, Losses
- **Low flow detection**

FEATURES

- **Large 6 line display**
- **EOS Technology**
- **NO_x Filtered**
- **Water Trap Indication**
- **High Altitude Compensation**

GENERAL SPECIFICATIONS

- **Operating Temperature:** 32° to 113°F (0° to 45°C)
- **Storage Temperature:** 0° to 113°F (-18° to 45°C)
- **Operating Humidity:** 15% to 90% R.H.
- **Back light:** Yes
- **Dimensions:** 8.54 x 4.18 x 1.86 inch
- **Item Weight:** 1.51 lb
- **Calibration:** Recommended Annually
- **Certification:** UK CA, CE Conformity, RoHS, REACH Compliant, AHRI 1260 standard
- **Battery Type:** NiMH (AA) 3
- **Accuracy:** ± (% of reading + # of least significant digits)

IMPORTANT SAFETY WARNINGS

 Read entire Safety Notes section regarding potential hazard and proper instructions before using this analyzer. In this manual the word **“WARNING”** is used to indicate conditions or actions that may pose physical hazards to the user. The word **“CAUTION”** is used to indicate conditions or actions that may damage this instrument. This analyzer must only be used in well-ventilated locations by trained and competent persons after due consideration of all potential hazards.

 To ensure safe operation and service of the tester, follow these instructions. Failure to observe these warnings can result in severe injury or death.











- Do not use this analyzer during electrical storms or in wet weather.
- To avoid false readings, charge batteries if a low battery indicator appears.
- Always adhere to national and local safety codes. Use proper personal protective equipment (PPE).

 This analyzer extracts combustion gases that may be toxic in relatively low concentrations. These gases are exhausted from the back of the analyzer.

 This analyzer is designed for trade professionals who are familiar with the hazards of their trade. Observe all recommended safety procedures that include proper lockout utilization and use of personal protective equipment that includes safety glasses, gloves and flame resistant clothing.

Users of portable gas detectors are recommended to conduct a “bump” check before relying on the unit to verify an atmosphere is free from hazard. A ‘bump’ test is a means of verifying that an instrument is working within acceptable limits by briefly exposing to a known gas mixture formulated to change the output of all the sensors present. This is different from a calibration where the instrument is also exposed to a known gas mixture but is allowed to settle to a steady figure and the reading adjusted to the stated gas concentration of the test gas.

SYMBOLS

	Low battery	°F	Degrees Fahrenheit
°C	Degrees Celsius		Pump Status
	Pump Start		Pump Stop
	Hold		Printing
	Navigate Down		Navigate Up
	Enter Key		Save Log

ANALYZER OVERVIEW

A. Infrared Printer Port

B. On/ Off (Power) Button

C. 6 Line Backlit Display

- Press any button to turn Back light on (will turn off after 10 seconds)

D. Protective Rubber Boot With Magnets

E. Status Bar Line

F. Data Hold Button: Short press to hold current data.

G. Pump Toggle Button: Long press to toggle pump on and off

H. UP Button

- Short press to navigate "UP".

I. Save Log Button: Long press to store data.

J. Print Report Button: Short press to print a report to IR Port. (will enter a print option if Wireless Module is fitted)

K. Down Button

- Short press to navigate "DOWN"

L. ENTER Button

- Short press select current option displayed
- Long press to activate some menu items

M. Rotary Selector Dial

N. Particle Filter (inside water trap)

O. Water Trap

P. LED Full Water Trap Indicator

Q. Serial Number: (under Protective Boot)

R. Sensors Fitted: (under Protective Boot) Indicates Sensors fitted in unit

S. Battery Compartment: (under Protective Boot)

T. Grip Indentation: Indentation for fingers to grip analyzer

U. Water Trap Drain Plug (Red plug; take caution NOT to damage plug when removing protective boot)

V. Battery Charge USB Adapter Connection

W. Temperature Connections

- Flue Probe Temperature: T1
- Inlet Temperature: T2

X. Flue Gas Inlet Connection

ANALYZER OVERVIEW (CONT.)

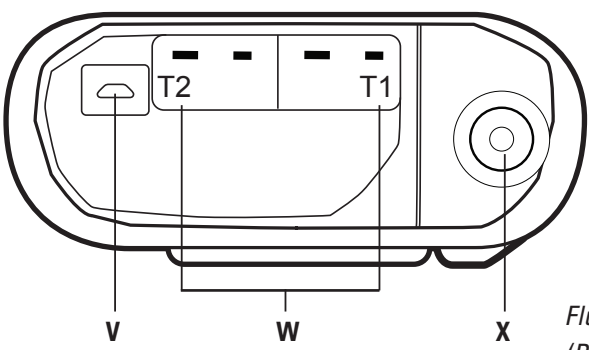
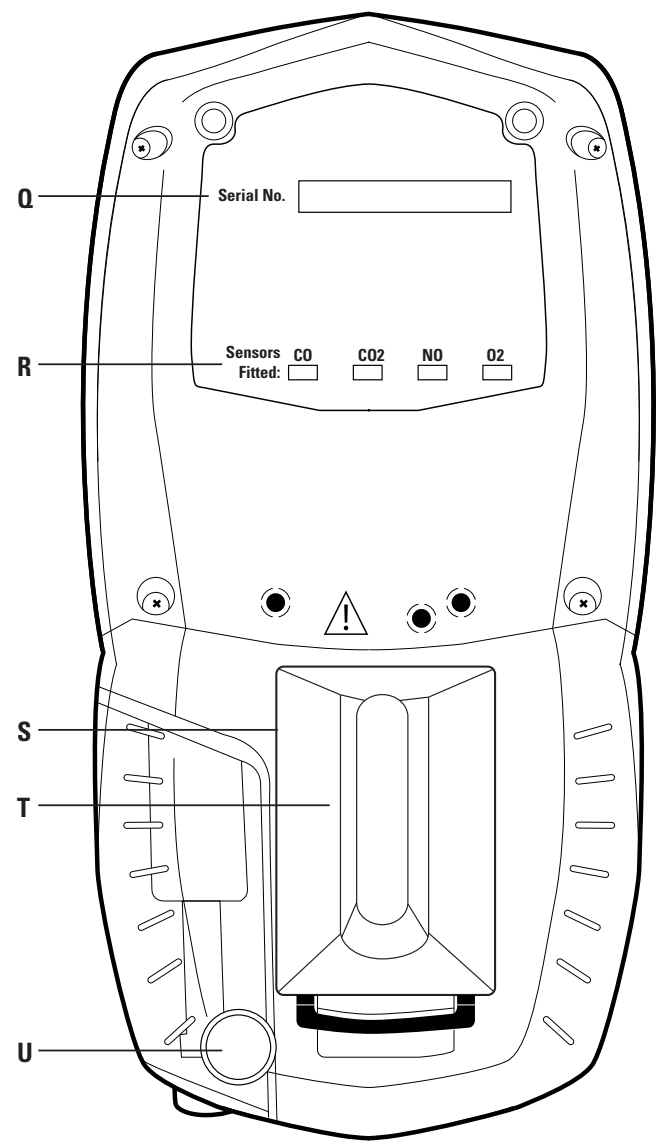
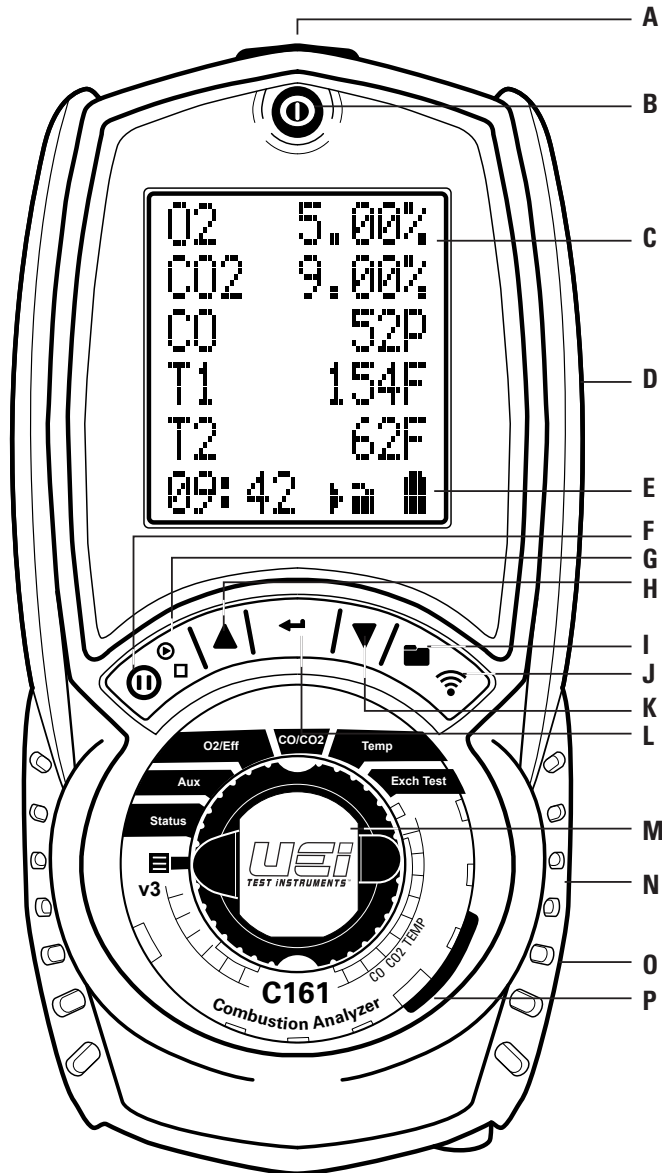

Flue Probe Temperature Plug
(Plugs into T1)

Narrow Pin **MUST** be on the
Right hand side.

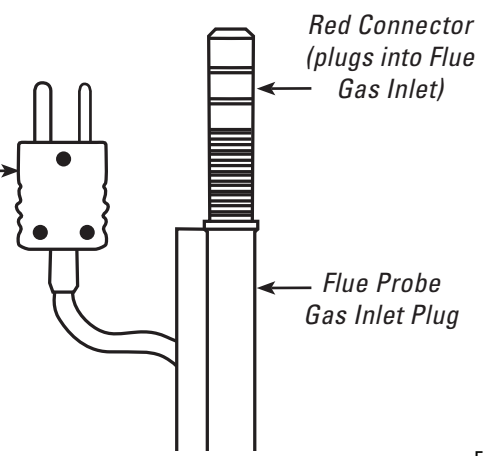

OVERVIEW

The direct measurement of CO₂ is achieved using UEi's own EOS technology sensor. CO₂ is set to zero in fresh air automatically after the initial 60 second countdown.

If "ZERO CO₂" is indicated, ensure the unit is in **outside fresh air** before selecting the "Purge" option. It is very important that re-zeroing is done in **outside fresh air** as indoor CO₂ levels are affected by human breath.

The analyzer has a protective rubber boot with magnets for hands-free operation and is supplied with a probe with an integral temperature sensor.

A low flow detection system warns of a low flow and switches the pump off, this also helps prevent water condensate ingress from overfilled water traps.

A large 6 line display provides the user with relevant information based on current activity including instrument status via the new intelligent Status Bar. All data can be printed via an optional infrared printer.

The C161 uses a new data storage system allowing up to 30 logs of any combination of Combustion, AUX or Temperature tests, rather than be restricted to an allowance of particular logs.

10 characters can be added to Line 1 of the header, 6 characters to Line 2 of Header of the printouts.

PRE TEST CHECKLIST

- Clean particle filter
- Water trap and probe line are empty of water
- Power on and zero
- All hose and thermocouple connections are properly secured
- Flue gas probe is sampling ambient FRESH air
- Water trap is fitted correctly to the instrument
- Flue temperature plug is connected
- Ensure water trap plug is inserted correctly

SETTING INLET TEMPERATURE

- Turn on and zero the analyzer without the flue probe connected to use ambient temperature.
- Connect flue probe thermocouple to T1 during zero countdown use for inlet ducted system.
- Connect a thermocouple to T2 to measure second temp source.

ANALYZER CONNECTIONS



WARNING!

Turning the pump off while the probe is in the flue will leave toxic gases inside the analyzer. Once data has been printed or copied, it is advisable to purge the unit with fresh air as soon as possible. To do this remove the probe from the flue and turn ON pump. Always allow the readings to return to zero (20.9% for O₂) prior to shutting the unit off. The meter will not switch off until the CO reading is below 20 ppm.



WARNING!

The probe will be hot from flue gases. Remove the probe from the flue and allow it to cool naturally. Do not immerse the probe in water, as this will be drawn into the analyzer and damage the pump and sensors.

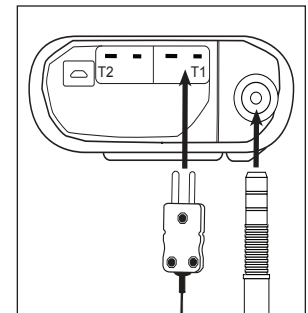

NOTE: Take care when inserting the temperature probes as the pins are polarized. Insert with the smaller pin (+) to the right.

EMPTYING & CLEANING THE IN-LINE WATER TRAP

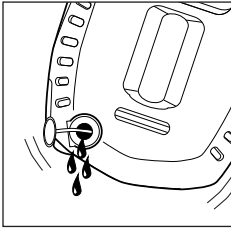

- Remove the rubber plug
- Allow the water to drain out
- Re-insert the rubber plug

CHANGING THE PARTICLE FILTER

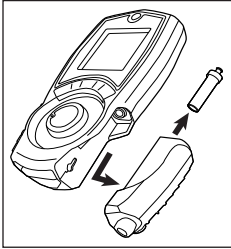

- Remove the protective rubber boot
- Slide the water trap unit from the analyzer
- Remove the particle filter from its' spigot and replace
- Slide the water trap back into position and replace protective rubber boot

QUICK START

Turn on the analyzer by pressing the On/Off Button for 2 seconds until the unit activates. As described the analyzer will perform a 60 second turn on purge. Once completed simply select the reading desired by the position of the rotary dial.

FRESH AIR PURGE

AIR PURGE
REMOVE
FLUE
PROBE

PURGE

Each time the analyzer is turned on it will perform a 60 second air purge, this is to clear the gas sampling path (including probe, if connected), and self calibrate the CO₂ detection system. For these reasons it is very important that the analyzer be in **outside fresh air** when powered on.

⚠ WARNING

When in the Rotary Dial positions AUX, Flue 1 or Flue 2 ; Press the Up or Down Buttons, scroll to CO₂ Zero. On the Purge option, short press the Edit Button, and a 60 second Purge will begin.

MEASURING FLUE GASES

After the initial countdown is finished and the analyzer is properly setup, put its' flue probe in the appliance's sampling point. The tip of the probe should be at the center of the flue. Use the flue probes depth stop cone to set the position.

With balanced flues, make sure the probe is positioned into the flue so no air can "back flush" into the probe.

NOTE: Ensure the flue probe handle does not get hot!

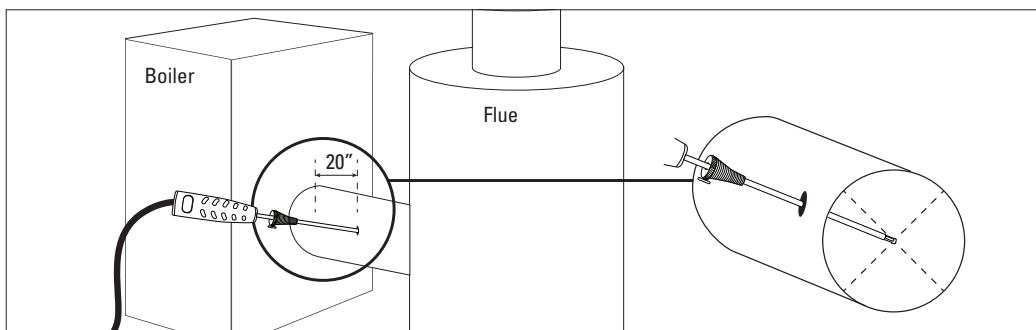

DISPLAY PARAMETERS

The large display is backlit with 6 lines, the last line is the Status Bar line.

Menu Screen

Time (settable parameter; HH:MM:SS, displayed in 24 hour clock format)

Date (settable parameter; MM:DD:YY)

Header (16 character, 2 line settable parameter; 10 characters can be added to Line 1 of the header, 6 characters to Line 2)

IR Print (KMIRP or IRP-2)

°C/°F (Selectable parameter)

Gas Unit (Selectable parameter; select between ppm(n), ppm, mg/kWh(n), mg/kWh, mgm3(n), mgm3)

Language (settable parameter; select between English, Espanol, Francais)

EFF (Efficiency; select between Efgn or Efgc except for Heavy Oil and Pellets)

O2 Ref (Selectable parameter; select between 0.0% to 20.0%)

Logs (if logs are saved, they will be displayed)

Code (for Authorized Service Personnel only)

Status Screen

Ti (Ambient temperature)

ATM (atmospheric pressure in mBars)

CAL (days until next calibration due)

AUX Screen

(Default selections can be changed by user to desired selections; select between O2, CO, Display Fuel Type, CAL, XAIR, LOSS, Efgn or Efgc, ATM, Ti, ΔT, T2, T1, CO2, COa, or CO_n for each line)

Default Selections Are:

O2 (displayed in %)

CO (displayed in ppm)

CO2 (displayed in %)

T1 (displayed in °F or °C, depending on selection in Menu Screen)

T2 (displayed in °F or °C, depending on selection in Menu Screen)

O2/Eff Screen

CO2 (displayed in %)

O2 (displayed in %)

Efficiency

Efgn (Nett efficiency)

Efgc (Gross efficiency)

T1 (displayed in °F or °C, depending on selection in Menu Screen)

T2 (displayed in °F or °C, depending on selection in Menu Screen)

CO/CO2 Screen

CO (displayed in ppm)

COa (O2++ displayed in ppm)

CO2 (displayed in %)

Loss (displayed in %)

XAIR (Excess Air, O2++ displayed in ppm)

Temp Screen

T1 (displayed in °F or °C, depending on selection in Menu Screen)

T2 (displayed in °F or °C, depending on selection in Menu Screen)

ΔT (Differential Temperature, displayed in °F or °C, depending on selection in Menu Screen)

Purge option

When the Rotary Dial is in AUX, O2/Eff or CO/CO2 ; Press the ▲ or ▼ Buttons to scroll to CO2 Zero. Press and hold ← to select. Press ← to start a 60 second Purge.

STATUS SCREEN

Select "Status" on the dial to view the following:

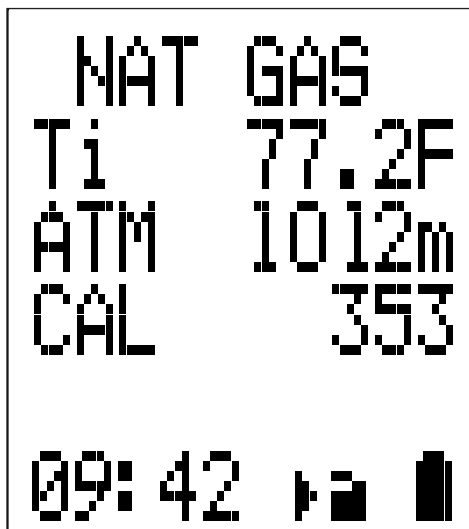

Current fuel selection. Use status bar to change fuel selection.

Select between: Pellets, Light Oil, Heavy Oil, LPG, Butane, Propane, Natural Gas, Bio Oil

Ambient temperature around the analyzer.

Current atmospheric pressure (mBar).

Shows number of days until next calibration is due.

Status Bar.

User Interface

The large six-line display will indicate 5 lines and the status bar (see pg. 9) the backlight will activate on each button press and turn off after 10 seconds of no activity. Navigation through the various start options and menu system is via the 3 button dedicated Up, Down & Enter Buttons. Button presses are categorized short press and long press (in the same manner as many modern consumer electronics).

Status Bar

The Status Bar provides the user with a concise indication of the instrument status, it incorporates an intelligent system that understands what the user is currently viewing on the display offering appropriate menu items as well as standard menu items.





Navigation through the Status Bar options is achieved via the ▲ and ▼ buttons when the Status Bar is visible on the display.

STATUS BAR

Status Bar Icons

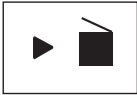
The icons are designed to provide quick and simple instrument status information without having to navigate complicated menu systems or detract from the job at hand.

Status Bar Icon Layout

Pump		<i>Pump on</i>
Pump		<i>Pump paused</i>
Sending Data		<i>Indicates data is being transmitted to either the App or the Printer</i>
Battery		<i>Battery Status indication</i>

Status Bar Menu Options

The Status Bar will offer the user Menu items based on the Selector Dial setting.

Status Bar Options Table

Status Info Available	Test Screen/ Dial Digital Position/ Test Screen				
	STATUS	AUX	O2/Eff	CO/CO2	TEMP
TIME	✓	✓	✓	✓	✓
FLUE SELECTED	✓	✓	✓	✓	✓
DATE	✓	✓	✓	✓	✓
CO2 FLUE		✓	✓	✓	

Date Option Date (Displayed as)



MENU

Using the Menu

The Menu position on the Rotary Dial allows for the customization of the default settings for the analyzer as per the user's requirements. Navigation through the Menu system is via the dedicated user's interface buttons (Up, Down, Enter).

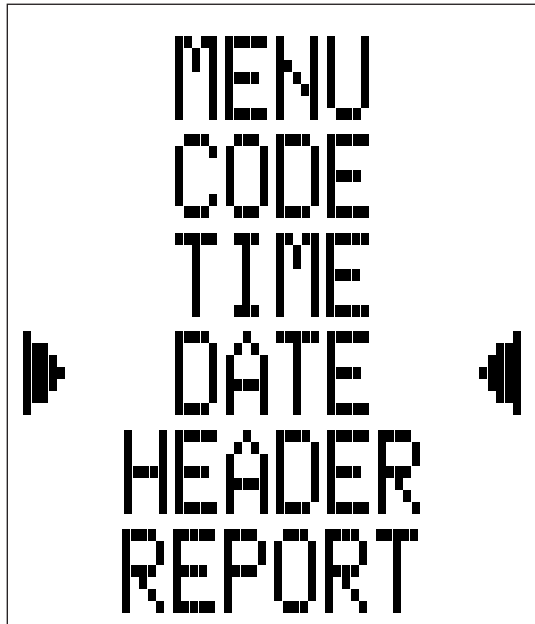

Menu Option to edit

As you navigate up or down through the Menu, the items will scroll accordingly, eventually back to the beginning.

Rotate Selector Dial to **MENU** to set up or customize your settings.

Selected parameter are centered, highlighted with arrow icons on either side.

Use ▲ and ▼ buttons to scroll menu options,

Press ← to a select a parameter to edit. Press ← button to scroll fields to change .

Press ▲ and ▼ buttons to change field contents.

Press ← to enter content selected.

Menu Items

MENU	Sub Menu	OPTIONS/COMMENTS
Time	HH:MM:SS	24 Hour Format (e.g. 7AM = 0:00:00, 7PM = 19:00:00)
Date	DD/MM/YY	
Header	LINE 1	Customer info displays on print outs
	LINE 2	Customer info displays on print outs
	EXIT	
IR Print	KMIRP	Select to print to KMIRP
	IRP-2	Select to print to IRP-2
Temperature Scale	°C	Select °F or °C.
	°F	
Gas Unit	ppm	
	ppm(n)	
	mg/m3	
	mg/m3(n)	
	mg/kWh	
Language	English	
	Espanaol	
	Francais	
Efficiency	Gross	
	Nett	
O2 ref		Used for "Normalized" readings. Default set to 3%, can be adjusted up or down.
Logs	VIEW	View current memory usage and view stored Logs
	DELETE ALL	
	EXIT	
Code		Password protected for authorized service agents only/ LEAVE SET TO "0000".

STORED LOGS MEMORY

The C161 utilizes a shared memory system much like a computer hard drive. The different Log types are stored sequentially until the shared memory area is full. This means the log types are not restricted to a smaller number of memory locations as the full memory capacity is available as required for Logs of any type.

To view the current memory usage status simply navigate to menu -----> LOGS, press the ← button to select the Log desired.

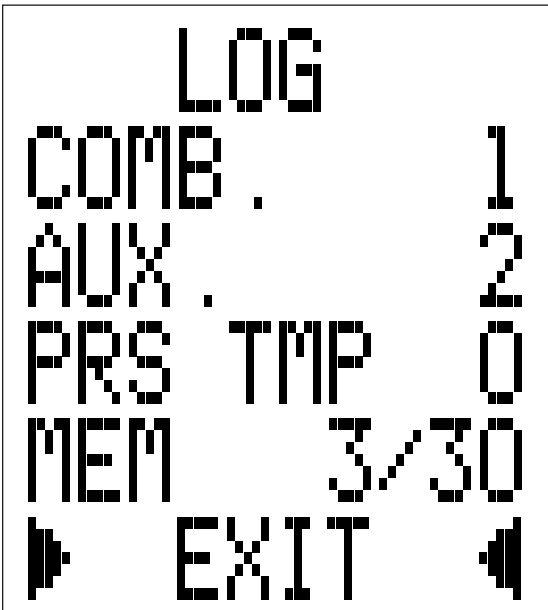

Number of stored Combustion Logs

Number of stored Auxiliary Logs

Number of stored Temperature Logs and "Pressure if fitted"

Total Memory Used

Menu Options

Menu Options

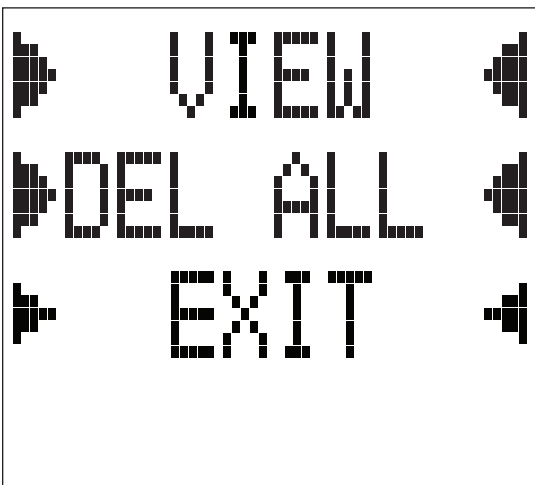

View stored Logs, this will enter the secondary menu to select the type of log to view (will only appear if data available).

Delete all stored Logs. To delete "long press" the ← button (will only appear if data available).

Exit back to the Main Menu

Viewing Stored Logs

Once the view has been selected from the Logs Menu the following screen will be displayed:

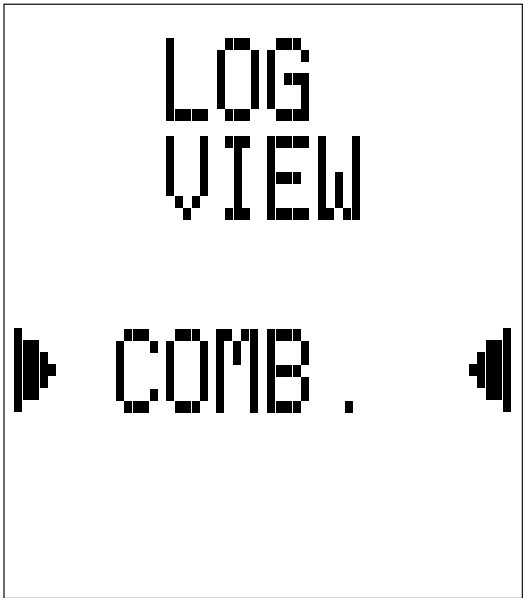

List of available Logs (Navigation and selection via the ▲, ▼ and ← buttons).

Log View Menu Options



View stored Combustion Logs (Option will appear if Logs are available).

View stored Auxiliary Logs (Option will appear if Logs are available).

Number of stored Temperature Logs and "Pressure if fitted" (Option will appear if Logs are available).

Exit back to previous menu

Navigating Stored Logs

Once the desired Log type to view has been selected, the first available stored Log will be displayed.

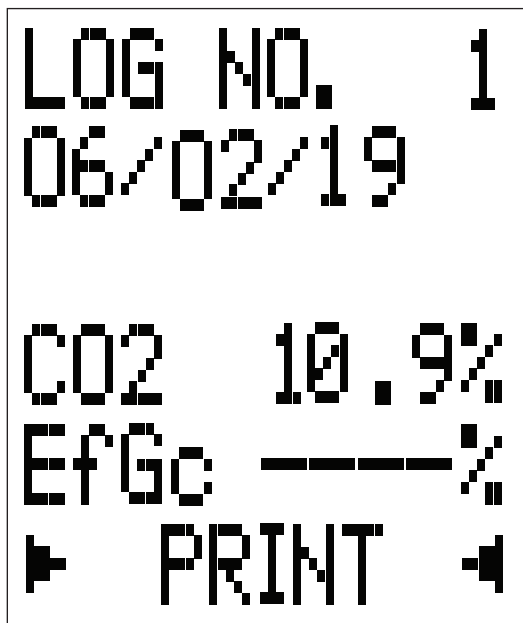

Log Number

Log time and date (this line will alternate between time and date of Log)

Log readings (information is specific to Log type)

Navigation Menu options

Log Navigation Menu Options

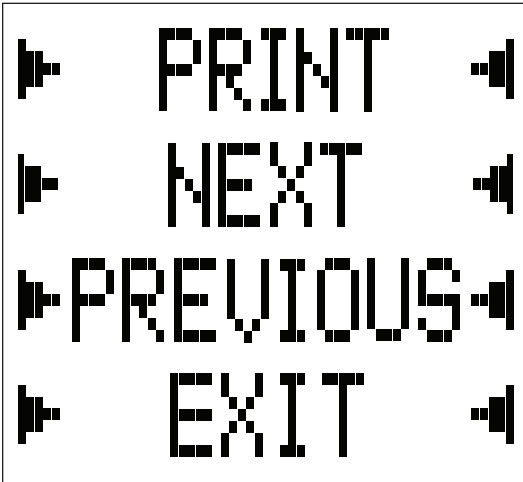

Print the currently selected Log

Navigate to the next available Log of the selected type (Option will only appear if there is more than one Log).

Navigate to the previously selected Log of the selected type (Option will only appear if there is more than one Log).

Exit back to the previous menu.

TEMPERATURE TESTING

Select the Temperature Rotary Dial position.

Temperature Display

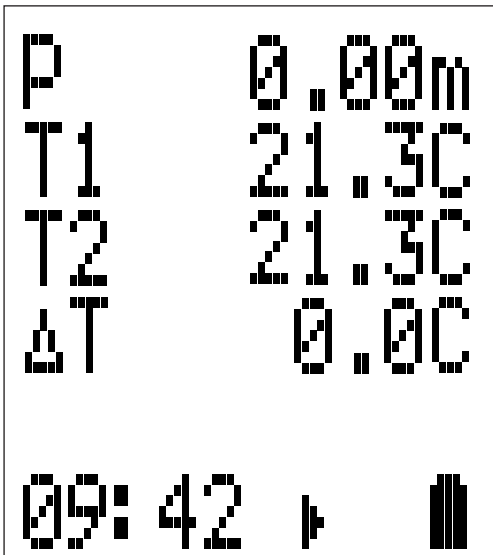

Pressure will only show if fitted

Use the T1 connection for the Supply temperature sensor.

Use the T2 connection for the Return temperature sensor.

Real time temperature difference

Viewing/Printing

Press  BUTTON to print the Temperature Screen.

HEAT EXCHANGER TEST

NOTE: Test results; O2, CO and Excess Air will show on the printout.

There are many methods to test heat exchanger integrity. One of these is to observe the Excess Air, O2 and CO readings both before and after the blower turns on. If the heat exchanger is sealed your O2 and CO readings should remain fairly stable. A breach in the heat exchanger may allow fresh air to be forced into the flue after the blower turns on due to a pressure increase in the plenum. The result may be a rise in the measured O2 in the stack gas and an increase in the Excess Air. In some sealed systems the fresh air drawn in through the breach may reduce the combustion air available leading to an increase in the CO reading. If either of these situations are present it is probable that there is a problem with the Heat Exchanger which may require additional testing and inspection.

NOTE: Many cracks are invisible to borescopes or the naked eye, and only open or separate from pressure or temperature changes during operations.

Select the Exch Test rotary dial position. Call for heat on the system. Observe and wait for O2 readings to stabilize.



Press ← for Exchange



Press ← for Run



Press ← for Start

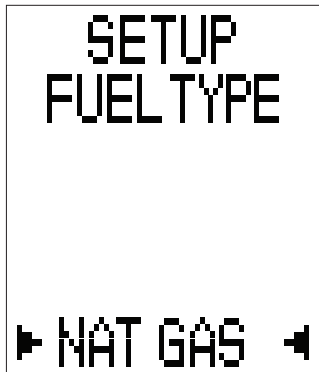

In Heat Exch Setup Screen, select Fuel type (Natural Gas, Bio Oil, Heavy Oil, Pellets, Light Oil, LPG, Butane, Propane)

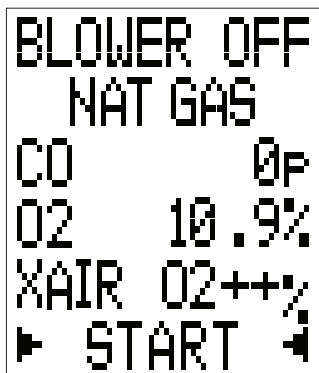

In Blower Off mode,
Press ← to start test

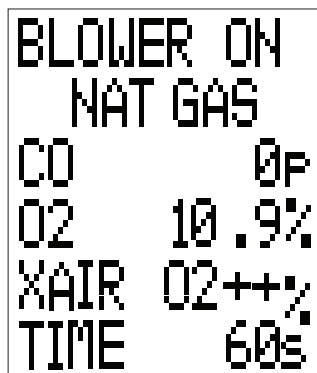

In Blower ON mode,
it will count down
from 60 seconds

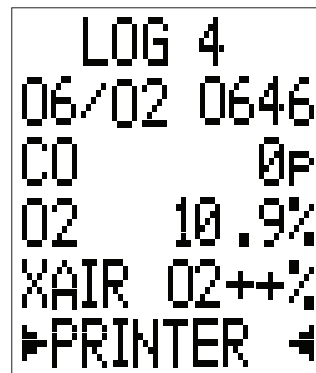

Test results will appear
on screen Press ←

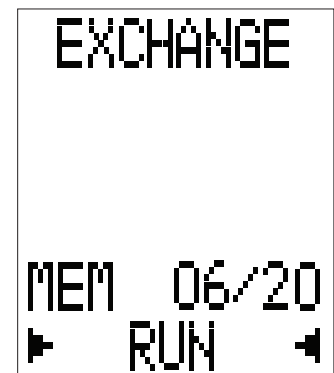

Press ▲ or ▼ to select
Run, View or Delete all
Press ← to select

PRINTOUTS

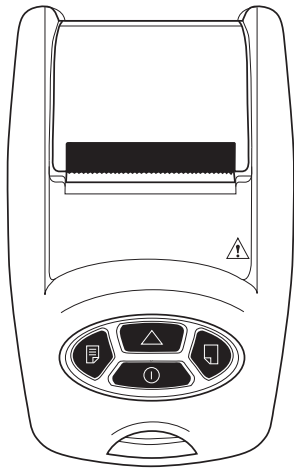

[IRP2]

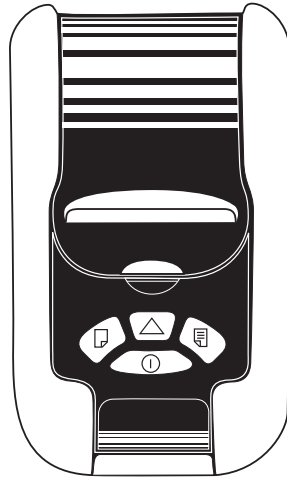

[KMIRP2]

Selecting a Printer

Rotate selector Dial to **Menu** Position.

Use **▲** or **▼** buttons to scroll to **IR PRINT**.

Press **←** button.

Use **▲** or **▼** buttons to select either **IRP-2** or **KMIRP** (KMIRP2) printer.

Press **←** button to save selection.

Printing

To print, simply press and release the PRINT BUTTON. Printing can be aborted by pressing the PRINT BUTTON again.

UEi Infrared Printer

Make sure the printer is switched on, ready to accept data and its infrared receiver is in line with the analyzer's infrared emitter (on top of the analyzer).

Combustion

UEi Test Instruments SW20157 0.3083	
NAME	
NUMBER	
SERIAL NO.	1234567890
DATE	11/16/19
TIME	13:19:07

CAL DUE	09/26/20

COMBUSTION	

FUEL	NAT GAS
CO2	% 0.11
O2	% 20.76
CO	ppm 1
CO/CO2	0.0009
T1	C ----
T2	C ----
Ti	C 83.9
NETT	% ----
EFFgc	% ----
LOSS	% ----
XAIR	% 02++

CUSTOMER	
.....	
.	
.....	
REFERENCE	
.....	
.	
.....	

Auxiliary

UEi Test Instruments SW20157 0.3083	
NAME	
NUMBER	
SERIAL NO.	1234567890
DATE	11/16/19
TIME	13:18:34

CAL DUE	09/26/20

AUXILIARY	

FUEL	NAT GAS
CO2	% 0.11
CO	ppm 0
O2	% 20.86
LOSS	% 0.1
XAIR	% 02++

CUSTOMER	
.....	
.	
.....	
APPLIANCE	
.....	
.	
.....	
REFERENCE	
.....	
.	
.....	

Pressure/Temp

UEi Test Instruments SW20157 0.3083	
NAME	
NUMBER	
SERIAL NO.	1234567890
DATE	11/16/19
TIME	13:19:29

CAL DUE	09/26/20

PRS/TMP	

T1	°F ----
T2	°F ----
Ti	°F ----
NETT	°F ----

CUSTOMER	
.....	
.	
.....	
APPLIANCE	
.....	
.	
.....	
REFERENCE	
.....	
.	
.....	

HEAT EXCH TEST

UEi Test Instruments SW20157 0.3083	
NAME	
NUMBER	
SERIAL NO.	1234567890
DATE	11/16/19
TIME	13:19:07

CAL DUE	09/26/20

EXCHANGE TEST	

FUEL	L OIL
BLOWER OFF	
O2	% 20.89
CO(n)	mg/kWh n -OR-
XAIR	% 02++
BLOWER ON	
O2	% 20.89
CO(n)	mg/kWh n -OR-
XAIR	% 02++
DURATION	SEC 60
DELTA	
O2	% 0.00
CO(n)	mg/kWh n 0
XAIR	% 02++

CUSTOMER	
.....	

SPECIFICATIONS

Parameter	Range	Resolution	Accuracy
Temperature Measurement			
Flue Temperature	32° to 1112°F (0° to 600°C)	0.1°F (0.1°C)	±(0.3% rdg +3.6°F (2°C))
Inlet Temperature (Internal Sensor)	32° to 122°F (0° to 50°C)	0.1°F (0.1°C)	±2°F (1°C)
Inlet Temperature (External Sensor)	32° to 1112°F (0° to 600°C)	0.2° (0.1°C)	1°F (0.5°C)
Flue Gas Measurement			
Carbon Monoxide	0 - 2000ppm	1ppm	±3ppm or ±5% of Reading (whichever is greater)
Carbon Dioxide	0 - 20%	0.1%	±0.3% Volume
Calculations			
Oxygen	0 - 21%	0.1%	±0.3% Volume
CO/CO ₂ Ratio	0 - 0.9999	0.0001	±5% of Reading
Efficiency (Nett or Gross)	0 - 99.9%	0.1%	±1% of Reading
Efficiency High (C)	0 - 119.9%	0.1%	±1% of Reading
Excess Air	0 - 119.9%	0.1%	±0.2% of Reading
Pre-programmed Fuels	Pellets, Light Oil, LPG, Butane, Propane, Natural Gas, Bio Oil, Heavy Oil		
Battery Life	>8 hours (continuous with pump on)		
Certification	The C161 is TUV-tested and certified to EN 50379, Parts 1-3 in accordance to 1st German Federal Emission Control Ordinance (BImSchV)		
Operating Conditions			
Temperatures	32° to 113°F (0° to 45°C)		
Humidity	15 to 90% RH, (non-condensing)		
Power Supply	Rechargeable batteries, USB Charging		
Physical Characteristics			
Weight	1.5 lb. (635g)		
Dimensions	H: 8.54" x W: 4.18" x D: 1.86" (H: 217 mm x W:106 mm x D: 47mm)		

The C161 is in conformity with the relevant Union harmonization legislation listed below:

Directive	Title
201430EU	Electromagnetic Compatibility (EMC)
201165EU	Restriction of the use of certain hazardous substances in electrical and electronic equipment (RoHS)

The following harmonized standards and technical specifications have been applied:

CERTIFICATION

The UEi C161 is TUV-tested and certified to EN 50379, Parts 1, 2 & 3 in accordance to 1st German Federal Emission Control Ordinance (BImSchV). Manufactured to meet AHRI 1260 standard.

EMC

EN507270:2015

Safety

EN61010-1:2010

RoHS

IEC62321-2:2013, IEC62321-1:2013; IEC62321-3-1:2013, IEC63321-5:2013, IEC623321-4:2013, IEC62321-7-2:2017, IEC62321-7-1:2015, IEC62321-6:2015

UK CA

Air Conditioning / Heat Pump

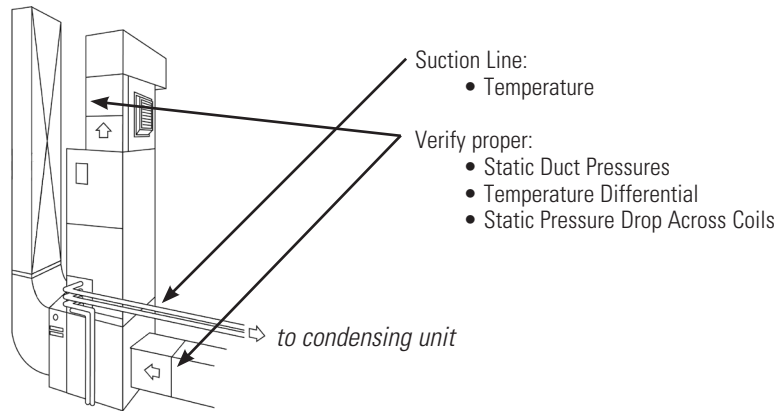

Boiler & Water Heaters & High Efficiency Modulating Hot Water Systems

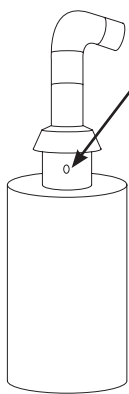

- Boiler**
Verify proper combustion:
- O₂
 - CO₂
 - CO Air Free
 - Stack Temp
 - Stack Draft

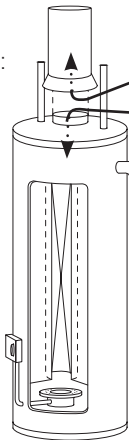

- Water Heater**
Draft
- Verify proper combustion:
- O₂
 - CO₂
 - CO
 - Stack Temp
 - Efficiency

HE Boiler Instant Water Heaters

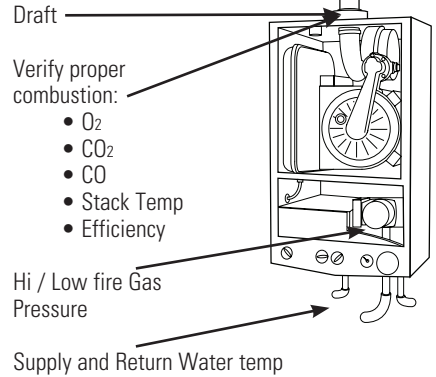

Furnaces: 80%

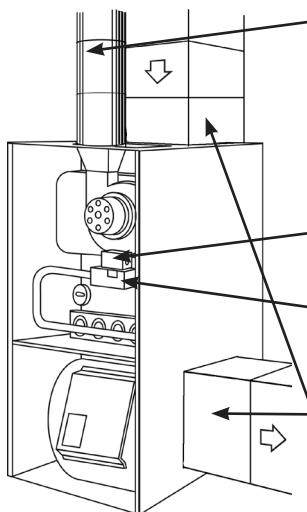

- 80% Furnace**
Verify proper combustion:
- O₂
 - CO₂
 - CO
 - Stack Temp
 - Vent Pressure
 - Efficiency
- Verify/Set Up
- Gas Pressure
- Test
- Limit Switch
 - Pressure Switch
- Verify proper operation:
- Static Duct Pressure
 - Temperature Rise
 - AC side Static Pressure Drop across coils

Furnaces: 90%

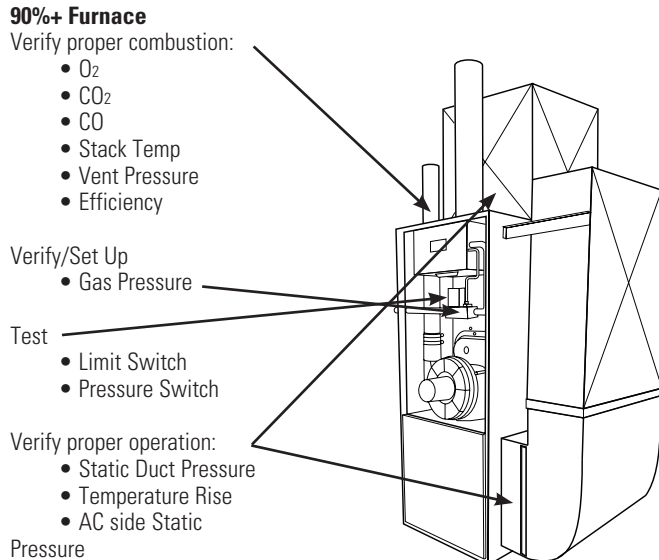

- 90%+ Furnace**
Verify proper combustion:
- O₂
 - CO₂
 - CO
 - Stack Temp
 - Vent Pressure
 - Efficiency
- Verify/Set Up
- Gas Pressure
- Test
- Limit Switch
 - Pressure Switch
- Verify proper operation:
- Static Duct Pressure
 - Temperature Rise
 - AC side Static Pressure Drop across coils

WHERE TO TEST (CONT.)

Furnaces (continued): Atmospheric, Gas & Oil

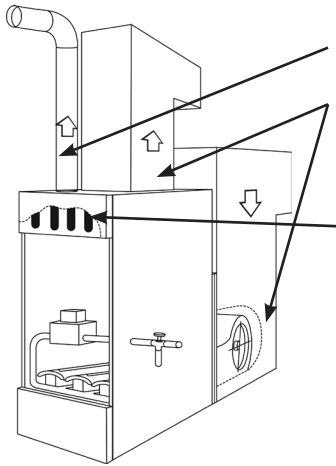

Atmospheric Furnace
Draft

- Verify proper
- Temperature Rise
 - AC side Static Pressure
 - Drop across coils

- Verify proper combustion:
- O₂
 - CO₂
 - CO
 - Stack Temp
 - Efficiency

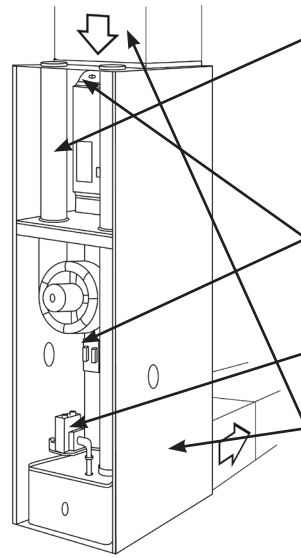

Natural Gas & Propane

Verify proper combustion:

- O₂
- CO₂
- CO
- Stack Temp
- Vent Pressure
- Efficiency

Test

- Limit Switch
- Pressure Switch

Set Up

- Gas Pressure

Verify proper:

- Static Duct Pressure
- Temperature Rise
- AC side Static Pressure
- Drop across coils

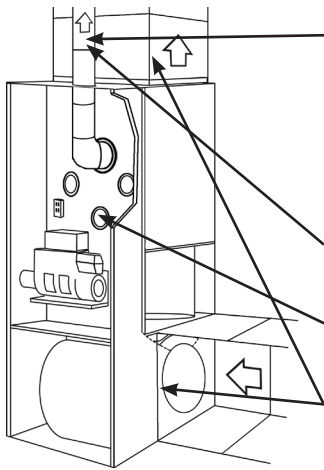

Oil Furnace

Verify proper combustion:

- O₂
- CO₂
- CO
- Stack Temp
- Stack Draft
- Efficiency

Test & Verify:

- Smoke

Set Up

- Over Fire Draft

Verify proper

- Static Duct Pressure
- Temperature Rise
- AC side Static Pressure
- Drop across coils

WHAT RESULTS ARE GENERALLY ACCEPTABLE

What Results Are Generally Acceptable

	Atmospheric Gas Fixed Burners	Gas Fired Burners	Oil Fired burners (#2 Oil Fuel)	Positive Overfire Gas & Oil
Oxygen	7 to 9% O ₂	3 to 6% O ₂	4 to 7% O ₂	3 to 9% O ₂
Stack temperature	325°F to 500°F	275°F to 500°F	325°F to 600°F	
Draft (Water Column Inches)	-.02 to -.4 InWC	-.02 to -.4 InWC	-.04 to -.6 InWC	-.02 to -.4 InWC
Carbon Monoxide (parts per million)	<100 ppm	<100 ppm	<100 ppm	<100 ppm
Overfire Draft (Water Column Inches)		-.02 InWC	-.2 InWC	0.4 to 0.6 InWC
Smoke			0 (manufacturer's recommendation)	

NOTE: Follow manufacture guidelines for the specific equipment being serviced

Typical Excess Air Level

	O ₂ % (measured)	Excess Air %
Natural Gas	3%	16.7%
LIGHT Oil	5%	31%
Coal	8%	62%

POWERING OFF

When you power off the C161, there is a 10 second purge.

Make sure you do not exceed the analyzer's operating specifications. In particular:

- Do not exceed the flue probes maximum temperature (1112°F)
- Do not exceed the analyzer's internal temperature range
- Do not put the analyzer on a hot surface
- Do not exceed the water trap's level
- Do not let the particle filter become dirty and blocked

View the displayed data to ensure that the stable operating conditions have been achieved and the readings are within the expected range.

POST TEST

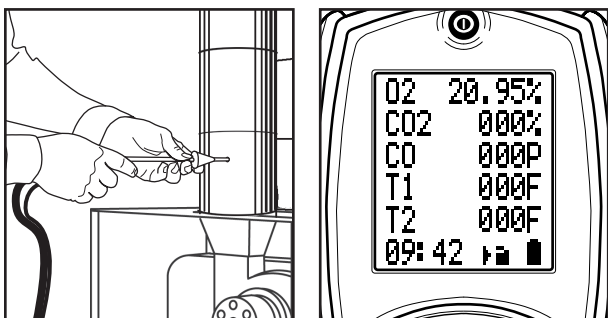

Remove the probe from the flue and allow analyzer to purge with fresh air until readings return to zero. O₂ to 20.9%, CO to Zero (Be careful the probe tip will be HOT).

GENERAL MAINTENANCE

- Re-certify your instrument annually to ensure it meets original performance specifications.



PERIODIC SERVICE WARNING

Repair and service of this instrument is to be performed by qualified personnel only. Improper repair or service could result in physical degradation of the instrument. This could alter the protection from personal injury this meter provides to the operator. Perform only those maintenance tasks that you are qualified to do.

- Keep your instrument dry. If it gets wet, wipe dry immediately. Liquids can degrade electronic circuits.
- Whenever practical, keep the instrument away from dust and dirt that can cause premature wear.
- Although your instrument is built to withstand the rigors of daily use, it can be damaged by severe impacts. Use reasonable caution when using and storing the meter.

COLD WEATHER PRECAUTIONS

It is important you keep your flue gas analyzer in a warm and dry place overnight

Electronic devices that become really cold, by being left in a vehicle overnight, suffer when taken into a warm room the next morning. Condensation may form which can affect the analyzer's performance & cause permanent damage. See operating and storage temperature specifications.

Electrochemical sensors used in flue gas analyzers can be affected by condensation or water being sucked into the analyzer, as the small apertures on top of sensors can become blocked with water, stopping sensors seeing flue gas. When this happens, oxygen or carbon dioxide reading will display as "—" & sensors may be permanently damaged

If you think that your analyzer is affected by condensation or water ingress, it may be possible to rectify the problem yourself. Simply leave the analyzer running in a warm place, with the pump 'ON' sampling fresh air for a few hours (use mains adapter/battery charger if needed). If, after doing this, you still experience problems please contact our Service Center.

REPLACING THE BATTERIES

This meter has been designed for use with both alkaline and rechargeable Nickel Metal Hydride (NiMH) batteries. No other types are recommended and will void warranty. The analyzer is supplied with 3 (AA) size NiMH rechargeable batteries. These should be installed into the instrument.



CAUTION

Take great care when installing the batteries to observe correct polarity. Always check the meter for operation immediately after installing new batteries.

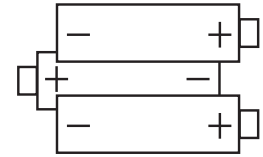

Using Rechargeable Batteries

The battery charger must only be used when NiMH batteries are fitted. Alkaline batteries are not rechargeable. Attempting to recharge alkaline batteries may result in damage to the product and create a fire risk.



WARNING

Do not try and charge the unit with Alkaline batteries fitted. Do not mix NiMH cells of different capacities or from different manufacturers, all cells must be identical.

Turn over the analyzer, remove the protective rubber boot and fit 3 "AA" NiMH rechargeable batteries in the battery compartment. **Take great care to ensure they are fitted with the correct battery polarity.** Replace the battery cover and the protective rubber boot.

Time and Date

When changing the batteries, the time and date will need setting.

Battery Disposal

Always dispose of depleted batteries using approved disposal methods that protect the environment.

Battery Charging

Ensure that you use the correct charger. This unit uses a 5V regulated charger. Ensure the batteries are fitted in the correct manner, and charge for at least 16 hours. Subsequent charges should be overnight. NiMH batteries may be charged at any time, even for short periods to conduct testing.

WARNING



Under NO circumstances should you expose batteries to extreme heat or fire as they may explode and cause injury. Always dispose of old batteries promptly in a manner consistent with local disposal regulations.

CANADIAN ANNUAL RECERTIFICATION SERVICES

KANE CANADA MEASUREMENT SOLUTIONS

All Canadian customers needing annual recertification services, please visit www.Kanetest.ca



Complete Care for Your Combustion Analyzer.

BACKED BY



When you:

**Request Recertification or Service Online
Within 1 Year of Purchase or Last Service**

UEi will:

10 Year Warranty: All UEi combustion analyzers have a standard 1-year warranty. Each recertification extends the warranty for 1 more year for up to **10 years** from the date of purchase.

Contractors who book recertification of a C160 series analyzer at www.ueitest.com/service within 12 months from either the date of purchase or the date of the last recertification will receive reduced service pricing¹ that lowers the cost of ownership and 2 additional benefits:

Same Day Service: All qualifying analyzers received for recertification through UEi Service+ are returned on the same business day, **GUARANTEED.**²

Free Shipping: UEi Service+ offers free shipping both to and from our service center. When customers book their recertification, they receive a prepaid UPS Ground shipping label.

¹Pricing subject to change without notice.

²Analyzers that include the additional NO (Nitric Oxide) sensor requires 48-hour turnaround.

PRODUCT REGISTRATION

Register Online

Registering you analyzer online is quick and easy. Just log in or setup an account, it only takes a couple of minutes. Once logged in you can register you analyzer by providing some product information and uploading a proof-of-purchase.

When it's time to request recertification, just log into your account, select the analyzer, select the service and place your order.

OTHER IMPORTANT FACTORS RELATING TO COMBUSTION

The three T's of combustion

- **Time:** Amount of time that the fuel and oxygen are together in the combustion chamber
- **Temperature:** How high the temperature is determines the rate of oxidation, or spread of combustion
- **Turbulence:** How well the fuel and air are mixed

These three factors are all interrelated and will move your results along the combustion curves.

COMBUSTION MEASUREMENT TERMS

Other parameters measured include Nett temperature, draft and efficiency.

Nett Temperature

Nett temperature is the difference between the combustion air entering the combustion chamber and the flue gas temperature past the heat exchange. This is used to determine how efficient the system is extracting heat from the combustion process in addition to the performance of the combustion process. On sealed systems that have ducted inlet air for combustion air, the Nett temperature must compare this air stream temperature with the flue gases. If the appliance simply uses room air for the combustion air, our analyzers have an internal temperature sensor in the handset, so it will use this temperature when calculating Nett temperature. The most accurate results for efficiency are obtained when measuring flue gases at the point where flue temperature (not flame temperature) is the highest.

Draft

Draft is the difference between the ambient pressure level and the pressure level in the flue.

This is created either by the natural buoyancy of the hot gases created in combustion lifting, or by an inducer fan that assists the flow of flue gases up the stack. Most combustion equipment will specify the amount of draft that is required for proper operation. Draft helps draw combustion air into the combustion chamber, and also helps in mixing the fuel and oxygen. Without proper draft, the combustion process can spill poisonous by-products into the space where the appliance is located. This can be a risk to those in the area, or create a danger to residents or employees working near the combustion equipment.

Efficiency

Efficiency is a measure of how well the fuel is burned to create heat, and how well the generated heat is captured for the intended use. The information used to create this value are based on the fuels heating value, the heat lost up the flue and the gas components in the flue gas. The original method to determine efficiency included many manual methods and lookup charts. As an example you would measure the CO₂ level and the stack temperature and then reference a slide scale that would give you the relative efficiency number. UEi's electronic combustion analyzers perform the measurements on a continuous basis, and can calculate the efficiency as adjustments are being made. Combine this with a printout and you are able to provide a before and after comparison of the combustion equipment in relatively little time as part of normal servicing. **Combustion efficiency is not the same as AFUE (annual fuel usage efficiency). AFUE is not measurable with any portable flue gas analyzer.**

Combustion Efficiency Calculations

This identifies three sources of loss associated with fuel burning:

- Losses due to flue gases:
 - Dry Flue gas loss, Moisture and hydrogen,
 - Sensible heat of water vapor, Unburned gas
- Losses due to refuse:
 - Combustible in ash, riddling and dust
- Other losses:
 - Radiation, convection, conduction other unmeasured losses

Nett efficiency calculations assume that the energy contained in the water vapor (formed as a product of combustion and from wet fuel) is recovered and the wet loss term is zero. Gross efficiency calculations assume that the energy contained in the water vapor is not recovered. Since the fuel air mixture is never consistent there is the possibility of unburned/partially unburned fuel passing through the flue. This is represented by the unburned carbon loss. Losses due to combustible matter in ashes, riddling, dust and grit, radiation, convection and conduction are not included.

CO Air Free

Certain standards (ANSI Z21.1) for Carbon Monoxide are stated in terms of air-free. Air-free refers to the concentration of CO in combustion gases undiluted with flue, or other gases containing little CO. This value is computed using an equation that takes into account the O₂ concentration of the flue gas.

- If 5% O₂ is measured (O_{2m}) in the flue then the CO gas value will be recalculated as if 0% were measured. The equation for air-free is as follows: $CO_{af} = CO \text{ PPM} \times [(20.9) / (20.9 - O_{2m})]$
- In our example if a reading of 325 PPM were measured then the air-free value would be calculated as follows:
 $CO_{af} = 325 \text{ PPM} \times [(20.9) / (20.9 - 5)]$ $CO_{af} = 325 \text{ PPM} \times [(20.9) / (15.9)]$ $CO_{af} = 427$

We may be given a limit on our gas range by the local authority, which stated that we must not emit more than 400-PPM Carbon Monoxide air-free. In the example we would be breaking the limit and corrective action should be taken to reduce the level of CO. Air-free values prevent false readings being submitted, e.g. allowing more air into the boiler will increase the oxygen level in the flue and dilute any toxic gas reading. Air-free referencing gives readings as if they were undiluted.

DISPOSAL



Caution: This symbol indicates that equipment and its accessories shall be subject to separate collection and correct disposal.

CLEANING:

Periodically clean your meters' case using a damp cloth. DO NOT use abrasive, flammable liquids, cleaning solvents, or strong detergents as they may damage the finish, impair safety, or affect the reliability of the structural components.

STORAGE:

Remove the batteries when instrument is not in use for a prolonged period of time. Do not expose to high temperatures or humidity. After a period of storage in extreme conditions exceeding the limits mentioned in the General Specifications section, allow the instrument to return to normal operating conditions before using it.

WARRANTY:

The C161 is warranted to be free from defects in materials and workmanship for a period of 1 year from the date of purchase. If within the warranty period your instrument should become inoperative from such defects, the unit will be repaired or replaced at UEi's option. This warranty covers normal use and does not cover damage which occurs in shipment or failure which results from alteration, tampering, accident, misuse, abuse, neglect or improper maintenance. Batteries and consequential damage resulting from failed batteries are not covered by warranty.

Any implied warranties, including but not limited to implied warranties of merchantability and fitness for a particular purpose, are limited to the express warranty. UEi shall not be liable for loss of use of the instrument or other incidental or consequential damages, expenses, or economic loss, or for any claim or claims for such damage, expenses or economic loss.

A purchase receipt or other proof of original purchase date will be required before warranty repairs will be rendered. Instruments out of warranty will be repaired (when repairable) for a service charge

For more information on warranty and service, contact:

www.ueitest.com Email: info@ueitest.com
1-800-547-5740

This warranty gives you specific legal rights. You may also have other rights, which vary from state to state.